

**E-Z-GO Long Travel Lift Kit  
2013.5 & Newer Electric T48  
Installation Instructions  
Part# 16-6239**

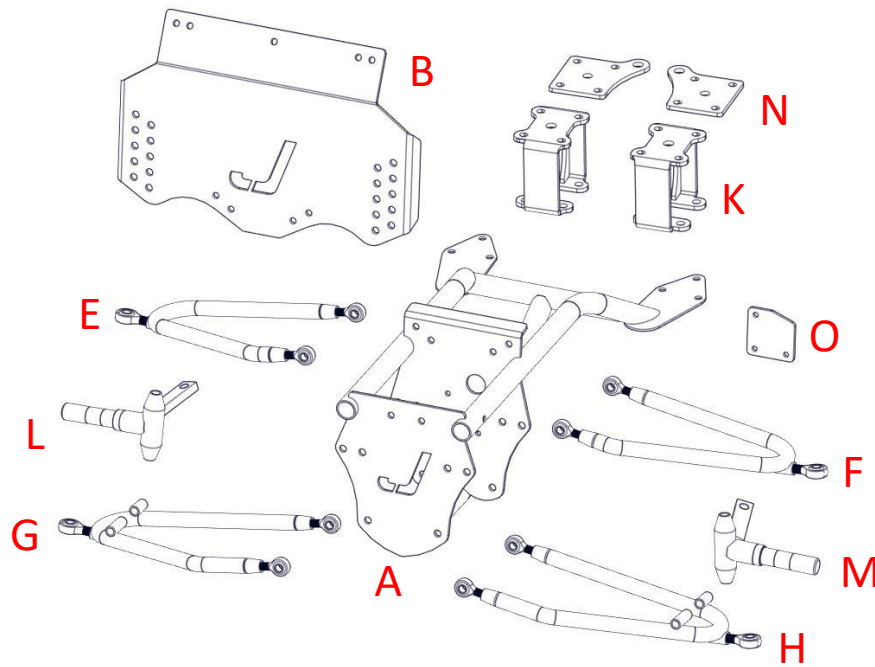

ITEM		QTY
A	JAKES SUB-FRAME	1
B	TOP FRAME SUPPORT	1
C	HARDWARE KIT	1
D	FRONT SHOCKS	2
E	PASSENGER SIDE TOP A-ARM	1
F	DRIVER SIDE TOP A-ARM	1
G	PASSENGER SIDE BOTTOM A-ARM	1
H	DRIVER SIDE BOTTOM A-ARM	1
I	STEERING EXTENSION	1
J	STEERING BOX	1
K	REAR RISER BRACKET	2
L	PASSENGER SIDE SPINDLE	1
M	DRIVER SIDE SPINDLE	1
N	REAR SHOCK MOUNT	2
O	STEERING BOX SPACER	1

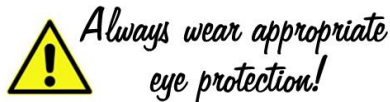

**FRONT ASSEMBLY**

1. Place the cart on jack stands.
2. Remove front wheels/tires.
3. Remove the dust cover from the front hubs and remove the cotter pin and slotted nuts from the spindle. This will allow you to remove the hubs from the car. Save the hubs and hardware for reinstallation.
4. Remove the front cowl by removing the rivets holding the front body on the cart.  
**NOTE: If you have a short angle drill you may not need to remove the front cowl-see FIGURE 2.**
5. Pull back the stock floor mat to expose the bolts holding the front leaf springs onto the car. You may need to partially remove the front portion of the rocker panels to allow you to pull the floor mat back.

6. Remove the top shocks from the stock top shock mount and discard rubber bushings. Loosely reinstall the top of the shocks to the stock shock mount. This will be to help hold the stock front sub-frame assembly to the car until it is ready to be removed.
7. Remove the bolts that are holding the front leaf springs to floor of the car. Save the bolts and leaf spring plates for reinstallation.
8. Remove the top bolt holding the stock steering extension to the steering column. Save this bolt for reinstallation.
9. Now the complete sub-frame assembly is ready to be removed. Have two people hold the sub-frame assembly and then remove the nuts that are holding the stock top shocks to the stock shock mount. This will allow you to remove the sub-frame from the car.
10. Loosely mount Jakes sub-frame (**ITEM A**) to the stock leaf spring mounting location using the stock nuts, bolts and mounting plates. See **FIGURE 1**.
11. Mount Jakes top frame support (**ITEM B**) to Jakes sub-frame (**ITEM A**) using the supplied 3/8x1 hex heads (3), 3/8x1 button head (1) and locknuts (4) as shown in **FIGURE 3**. Securely install these four bolts. from the left on the bottom with the nut towards the front of the cart for steering clearance.
12. Line Jake's top frame support holes up with the outside holes on the top shock mount frame. Using Jakes top frame support (**ITEM B**) as a guide; drill a 3/8" hole in the frame as shown in **FIGURE 2** and drill the remaining 2 holes to 3/8". Securely install the top of the top frame support to the 3 holes you just drilled using the supplied 3/8x1 and locknuts.
13. Securely install the sub frame to the stock leaf spring mounts and double check all sub frame and top frame support bolts are securely tightened.
14. Using the supplied 7/16 x 1 bolt, tapered spacer and locknut, install the top of the shocks (**ITEM D**) to the next to top inside hole as shown in **FIGURE 4**.  
**NOTE: The larger end of the tapered spacer goes to the shock mount plate and the narrower end goes to the shock as shown.**  
**NOTE: The shock gets installed with the air valve up as shown. The shocks come pre-charged. This is NOT an adjustment valve. If for any reason you leave the air out of the shocks you must set the air regulator on the air compressor to 85 psi and charge. The only way to check the air pressure in the shock is by performing the prior 85 psi step. If you check it with an air gauge you will let all the air out immediately and the shock will not function properly. The shocks are adjustable for a softer or stiffer ride. For the softest ride make sure the bottom adjusting nut is just snug against the spring then tighten the top jam nut against the adjusting nut. The further down you run the adjusting nut compressing the spring will stiffen the ride. Always make sure the top jam nut is tight against the adjusting nut.**

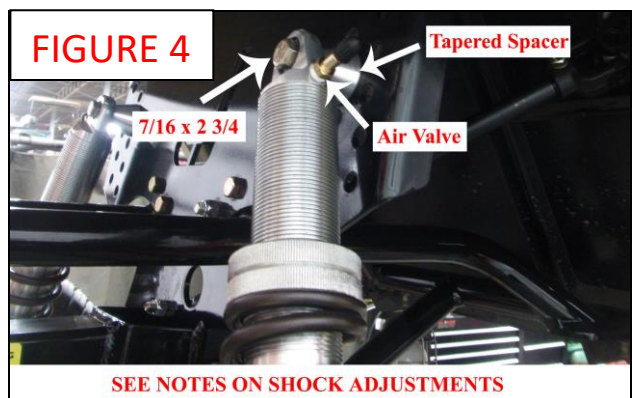
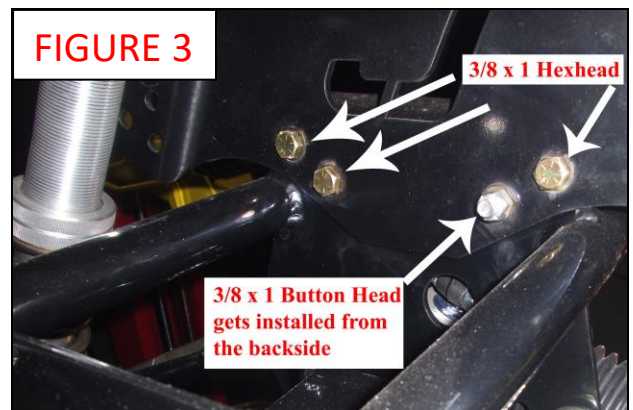
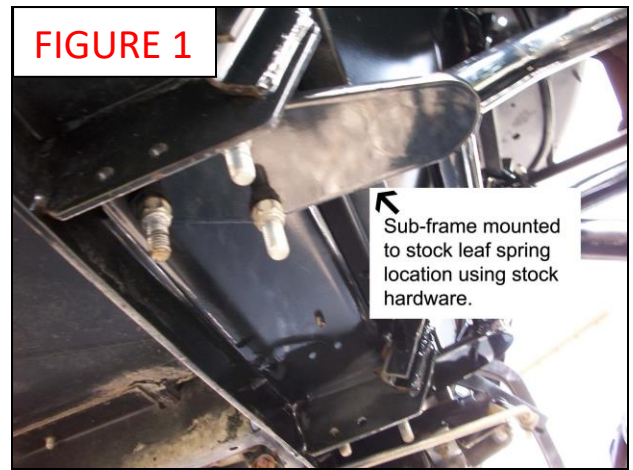



15. Mount Jake's bottom A-Arms (ITEMS G&H) to the sub-frame using the supplied 7/16 x 1 1/4 bolts and locknuts as shown in **FIGURE 5**. The a-arms are side specific; the tabs for mounting the shocks go up on each side.

**NOTE: A-Arms are marked P-Top, P-Bottom, D-Top, D-Bottom. P=passenger side, D=Driver side.**

16. Mount the shocks (ITEM D) to the bottom A-Arms (ITEMS G&H) using the supplied 7/16 x 5 1/2 bolts, spacers and locknuts as shown in **FIGURE 5**.

**NOTE: The spacer goes to the back side of the shock and has bevel on one end that goes towards the shock.**

17. Mount Jake's top A-Arms (ITEMS E&F) to the sub-frame using supplied 7/16 x 1 1/4 bolts washers and locknuts as shown in **FIGURE 5**.

**NOTE: The a-arms are side specific, the bent arm goes towards the front of the car and the spud for the heim end faces down as shown.**

18. Attach Jake's spindles (ITEMS L&M) to the A-Arms using the supplied 1/2 x 7 bolts, heim spacers and locknuts as shown in **FIGURE 6**.

**NOTE: The spindles are side specific, the steering arms go towards the rear and will angle slightly up and towards the center of the cart. There are 2 heim spacers used per side. The first heim spacer goes between the head of the bolt and the top heim with the flat side against the bolt head. The second heim spacer goes between the locknut and bottom heim with the flat side against the locknut as shown.**

19. Loosely mount Jake's steering extension (ITEM I) to Jake's steering box (ITEM J) using the supplied 3/8 x 1 1/4 bolt and locknut. There is a small end and large end on the steering extension, the small end goes to the steering box. Now you want to center the steering box. Using the steering extension turn the extension by hand which will turn the steering box, turn the extension until it reaches its furthest point. Now turn the extension the other way until it reaches it full extension while counting each revolution. Take half the number of revolution and turn the other way this amount. This will center your steering.

20. Install the supplied spacer plate (ITEM O) to the flat side of the steering box using the supplied 5/16 x 4 bolts, do not install the nuts yet. The bolts will run through the steering box with the spacer plate on what will be sub-frame end of the steering box. Loosely install the steering box assembly to the sub-frame with the supplied 3/8 x 4 bolts, do not install the locknuts at this time. Using the stock pinch bolt mount the steering extension to the stock steering column and securely tighten. Using the supplied lock nuts securely install the steering box to the sub frame as shown in **FIGURE 7**.

21. Attach the tie rod ends to the spindles as shown in **FIGURE 6**.

22. Install the stock hubs to the spindles using the stock hardware.

23. Install Jake's recommended 23x10.5x12 or 22x11x10 offset wheels/tires.

**NOTE: Your stock wheels/tires will not work.**

24. Adjust toe-in. Proper toe-in should be approximately 1/8" in. To adjust the toe loosen the jam nuts on the tie rod ends and using an adjustable wrench turn each tie rod end. This will adjust your toe. When you have the front portion of the front tires 1/8-1/4" narrower than the rear portion of the front tires retighten the jam nuts.

25. **SECURELY TIGHTEN ALL NUTS AND BOLTS.**

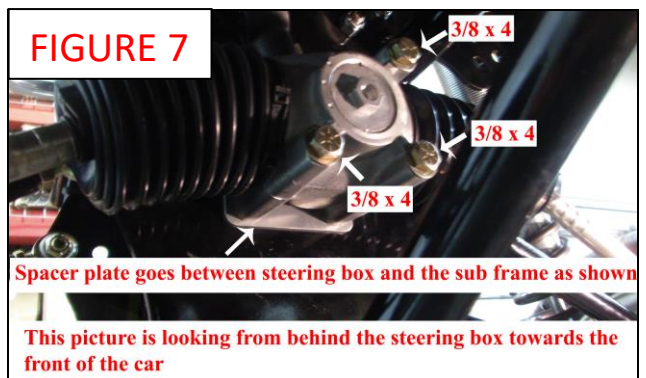
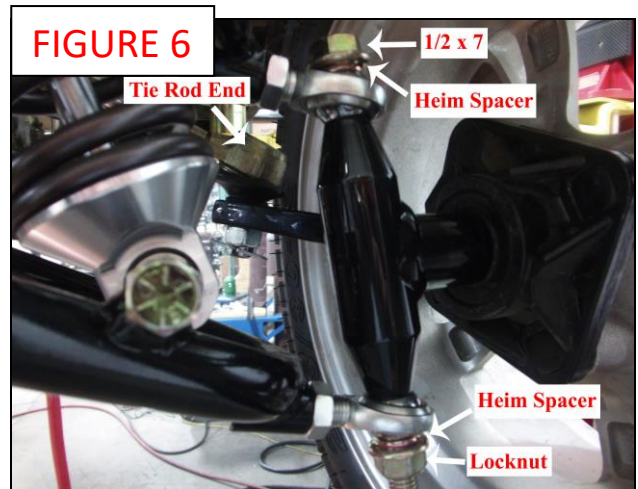
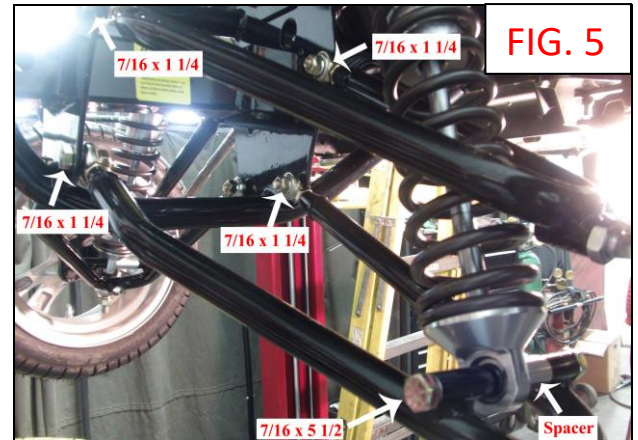

## **REAR INSTALLATION**

1. Jack up the rear end of the cart and place jack stands on the frame in front of the springs. Place a car jack under the rear-end housing of the cart. You will be installing larger wheels and tires so raise the cart high enough to accommodate the additional height.
2. Remove the wheels and tires.
3. Unbolt the bottom of the shocks. Clean and lubricate these bolts for later use.
4. Unbolt the rear leaf springs from under the cart. Using the car jack lower the rear of the cart.
5. Some models have a rubber bump stop on both the driver and passenger side of the axle. If your car has a rubber bump stop unbolt it and remove. This will not be reused.
6. Place the rear lift mounts (**ITEM K**) to the driver and passenger side of the stock leaf spring mounting plate as shown in the illustration.

**NOTE: The rear lift mounts are not side specific. When mounting make sure the cut out is to the outside for clearance of factory brake mounts that come off the top.**

7. Place the leaf springs on top of the risers.
8. Place JAKES rear shock plates (**ITEM N**) on top of the leaf springs with the shock mount holes facing the rear of the cart and towards the center. Using the supplied 3/8 x 7" bolts, pass bolt through shock plates, through the rear risers and through stock spring plate, with the leaf springs sandwiched in between them as shown in the picture below.
9. Make sure you tighten these bolts evenly.
10. Attach the bottom of the shocks to JAKES new shock mounts on the rear shock plates using the stock nuts and bolts.
11. Double check all nuts and bolts for tightness.
12. Install JAKES recommended wheel and tire size 22 x 11 x 10 wheels and tires with a 3 x 5" offset for maximum performance.

**NOTE: Your stock wheels and tires will NOT work.**

13. Included is a warning label which is to be placed on the steering column or another visible area and is to be read by all operators.

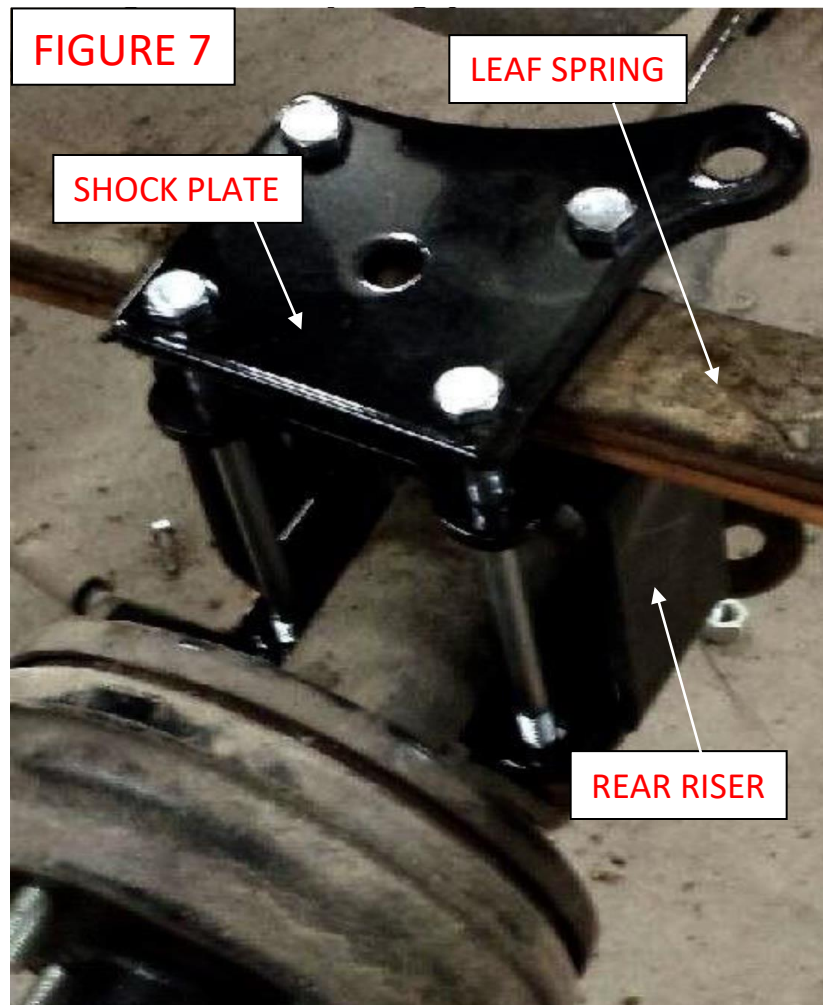



#### Indemnification And Insurance Agreement

High Performance Enhancement Kit purchaser assumes sole and entire responsibility for, and shall indemnify and save harmless Nivel LLC, from any and all claim, liability, responsibility, and persons or property that may be sustained in connection with the use of any product before or after purchase, including but not limited to high performance enhancement lift kits. The High Performance Enhancement Kit purchaser also shall indemnify Nivel LLC harmless with respect to any and all liability that may be incurred.

Golf Cars are recommended for use only by those aged 16 and older. Golf Cars can be especially hazardous to operate. Always remember that riding and alcohol/drugs don't mix. Never ride on public roads. Never carry more than two passengers (except shuttles and trams). Never engage in stunt driving. Avoid excessive speeds and be particularly careful on difficult terrain. Nivel LLC reserves the right, at any time, to discontinue or change specifications, prices, designs, features, models, or equipment without notice and without incurring any obligation.

© Copyright Nivel LLC  
All Rights Reserved